

Waterproof Ring Lights

HLDR-IP Series

Waterproof Light Unit for the Routine Cleaning of Manufacturing Lines
in the Food and Pharmaceutical Industries

Waterproof
IP67

High output
Condensing irradiation

**Red
White
UV**
Lineup

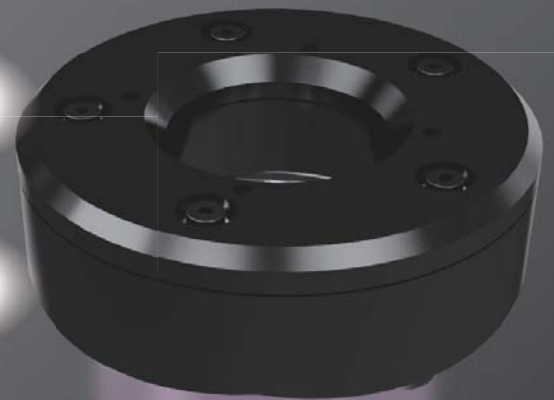

Applications | Adhesive application inspection
Printing inspection
Defect inspection
External inspection etc.

Waterproof Ring Lights HLDR-IP series



Features

- IP67 Compliance
- Uses an M12 connector
- Safe to Use when Washing Lines
- Ensures brightness with condensing irradiation
- Lineup includes red, white and UV (365 nm)

● IP67 Compliance

Waterproof and dustproof structure for use in harsh environments!

Optimal waterproof Light Unit for sites where the cleaning of manufacturing lines is essential, such as for food and pharmaceuticals.

Eliminates the need to worry about exposing Light Unit to water when cleaning.



■ Waterproof cable

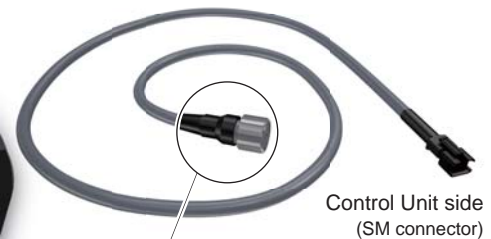

Control Unit side (SM connector)

Uses an M12 connector!

Connect this cable to the Light Unit to block water and dust.

1, 2, 3, and 5 m cable lengths are available.

● Safe to Use when Washing Manufacturing Lines

● When washing manufacturing lines



Food, pharmaceuticals, etc.

● For manufacturing lines that use water



Automotive parts, etc.

Condensing Irradiation for Brightness

HLDR-IP series features condensed, waterproof ring lights that ensures brightness with a condensing lens.

Condensing irradiation image



LWD
0 mm
* Bottom of housing as reference

Recommended range

± 10 mm centered on 126.5 mm

116.5 mm

126.5 mm

136.5 mm



Condensing range

- Red** Approximately ϕ 40 mm
- White** Approximately ϕ 35 mm
- UV** Approximately ϕ 40 mm

LWD=116.5 mm

Brightness
Approximately 59,000 lx

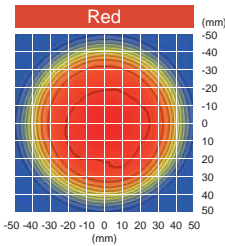

Brightness
Approximately 138,000 lx

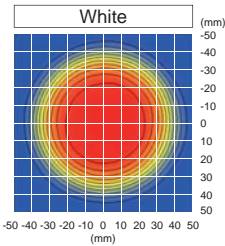

Brightness
20.4 mW/cm²

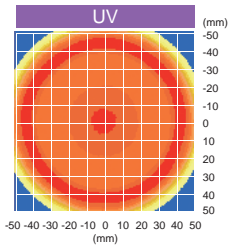

Output level (%)
100
0

* The values for red and white are measured values. (These values are not guaranteed.)

* Values are simulated for UV. (These values are not guaranteed.)

LWD=126.5 mm

Brightness
Approximately 53,000 lx

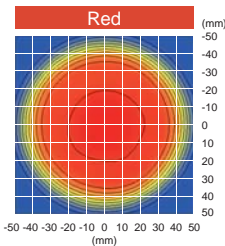

Brightness
Approximately 124,000 lx

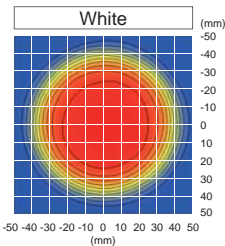

Brightness
18.6 mW/cm²

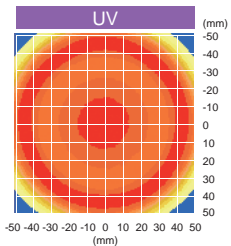

Output level (%)
100
0

* The values for red and white are measured values. (These values are not guaranteed.)

* Values are simulated for UV. (These values are not guaranteed.)

LWD=136.5 mm

Brightness
Approximately 47,000 lx

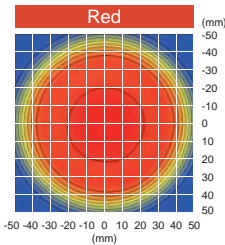

Brightness
Approximately 113,000 lx

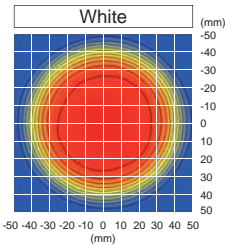

Brightness
16.8 mW/cm²

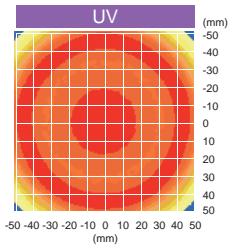

Output level (%)
100
0

* The values for red and white are measured values. (These values are not guaranteed.)

* Values are simulated for UV. (These values are not guaranteed.)

* Condensed near LWD=126.5 mm.
* If the recommended range (\pm 10 mm centered on 126.5 mm) is exceeded, uniformity is lost and imaging might be affected.
* LWD is the distance from the Light Unit to the workpiece.

* This data is provided for reference. It should not be considered a guarantee of product quality.

Applications

- Adhesive application inspection for food containers
- Defect inspection of metal parts

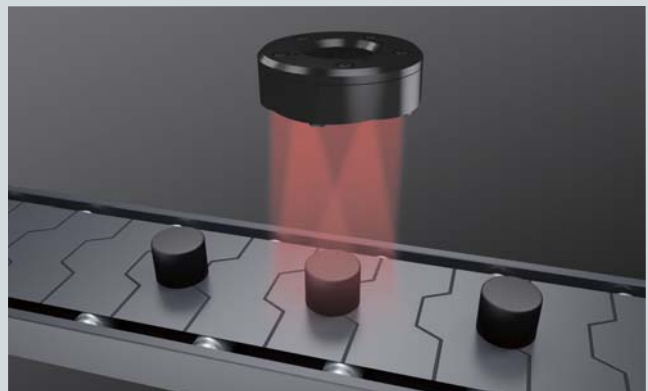
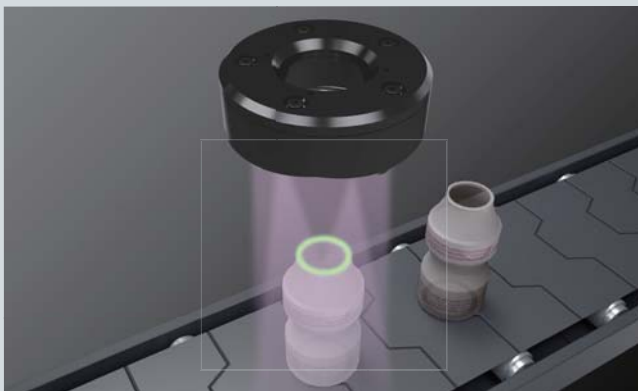

Specifications

● LED Light Unit

Model	HLDR-IP67-100RD	HLDR-IP67-100SW	HLDR-IP67-100UV2-365
Direct number	1006968	1006969	1006961
LED color	Red	White	UV
Input voltage (max.)	DC24 V		
Power consumption (max.)	18 W		
Peak wavelength / Correlated color temperature (typ.)	627 nm	6,500 K	365 nm
Connector	M12 (plug)		
Polarity	1: (24 V+), 2: Not connected, 3: GND (-), 4: Not connected		
Cooling method	Natural cooling		
Operating environment	Temperature: 0 to 40°C, Humidity: 20 to 95% RH (with no condensation)		
Storage environment	Temperature: -20 to 60°C, Humidity: 20 to 85% RH (with no condensation)		
CE Marking	Safety standard: EN62471 compliant		
Environmental regulations	RoHS compliance		
Protective structure	IP67 (JIS C 0920)		
Case material	Body: Aluminum alloy (black anodized) Screws: SUS Washers: SUS, Elastomer (TPE) Connectors: PA resin Lens: Silicone		
Weight (max.)	420 g		
Light spectrum			

- * This data is provided for reference. It should not be considered a guarantee of product quality.
- * About direct numbers: You can easily access the target product information page simply by entering a 7-digit number in the direct number field on the CCS website (machine vision page).

● Dedicated cable

Model	FCB-1-M12	FCB-2-M12	FCB-3-M12	FCB-5-M12
Direct number	3000940	3000941	3000942	3000943
Cable length	1 m	2 m	3 m	5 m
Weight (max.)	70 g	125 g	180 g	305 g
Connector	Light Unit side: M12 (socket), Control Unit side: SMR-03V-B (JST)			
Outer diameter	φ6 mm			
Case material	Light Unit side connector: Soft PBT Cable: PVC Control Unit side connector: Nylon			

"IP67" indicates the level of protection against foreign material entering electrical instruments.

The 1st numeral "6" indicates the following level of protection:

- No dust inside the instrument. (dustproof)

The 2nd numeral "7" indicates the following level of protection:

- No damage when submerged in water at the rated pressure for the rated time. (watertight type)
- Can be submerged in water to a depth of 1 m (for instruments with a height of less than 850 mm) for 30 minutes.

Control Unit compatibility

Please choose from the standard Control Units offered by CCS.
See the relevant catalogs or our website for details.

Series name PD3 series, PD2 series, PSB series, BB series (excluding strobe types)



- * Cannot be used in combination with Strobe Control Units (PTU2-3024, BB-V24S30-M, BB-V24S30-S). ON/OFF control is possible via the strobe mode or ON/OFF mode of the PD3 series, and constant lighting Control Units (PD2 series, BB series, etc.).

Dimensions (mm)

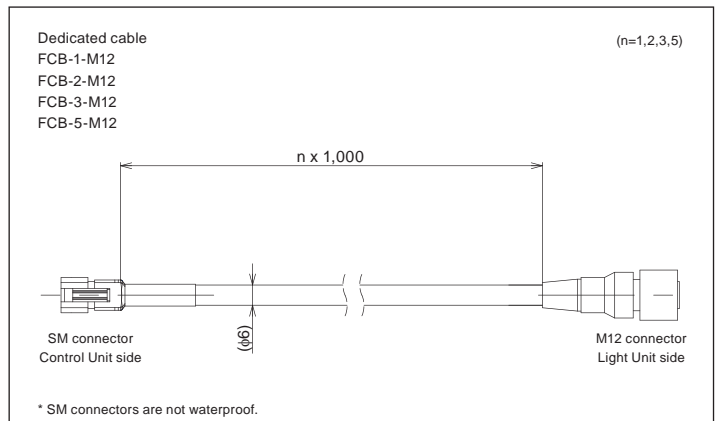
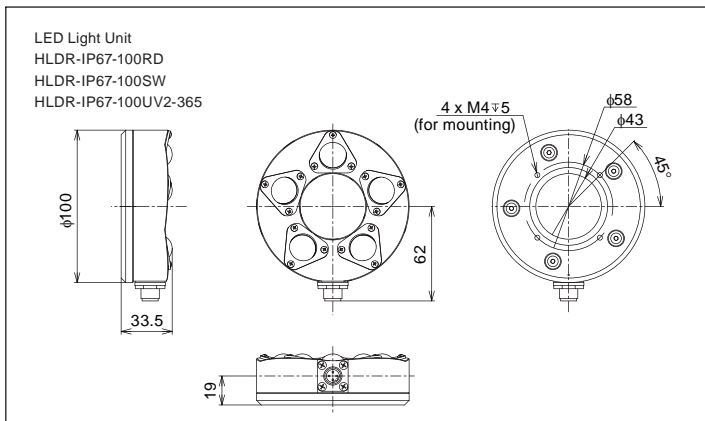

● Cautionary information regarding waterproofing

CAUTION

- After cleaning manufacturing lines, be sure to wipe away any moisture remaining on the lens. Imaging can be affected by moisture on the lens.
- Use water to wash away any cleaning agent adhered to this product.
- Use water to wash away any oils or chemicals adhered to this product.
- The Control Unit connectors (SM connectors) on dedicated cables are not waterproof.

● Cautionary information regarding UV products

CAUTION

- Do not expose your eyes or skin to direct UV irradiation.
- When using UV Light Unit, be sure to wear UV blocking eyewear and avoid looking at irradiated parts (light-emitting parts).
- Do not turn on UV-LED irradiation parts (light-emitting parts) if they are facing someone's eyes.
- Wear long sleeves and gloves to protect your skin from UV irradiation.
- Carefully inform all persons in the area around this product of the dangers of UV-LED.



● "CCS", "LIGHTING SOLUTION", and "HLDR" are registered trademarks or trademarks of CCS Inc.

CAUTION

- To use this product safely and correctly, be sure to read the *Instruction Guide* before use. ● The design of this product is subject to change without notification.

CCS Inc.

■ **Headquarters**
Shimodachiuri-agaru, karasuma-dori, kamigyo-ku,
Kyoto 602-8011 JAPAN
TEL : +81-75-415-8284 / FAX : +81-75-415-8278
URL : <http://www.ccs-grp.com/>
E-mail : sales@ccs-inc.co.jp

■ **CCS America, Inc**
5 Burlington Woods Suite 204 Burlington, MA 01803 USA
TEL : +1-781-272-6900 / FAX : +1-781-272-6902
URL : <http://www.ccsamerica.com/>
Email : info@ccsamerica.com

■ **CCS Europe NV/SA**
Bergensesteenweg 423, Bus 13
1600 Sint-Pieters-Leeuw, Belgium
TEL : +32-(0)2-333-0080 / FAX : +32-(0)2-333-0081
Email : info@ccseu.com

■ **CCS Asia PTE LTD**
63 Hillview Avenue #07-10, Lam Soon Industrial
Building, Singapore 669569
TEL : +65-6769-1669 / FAX : +65-6769-3422
URL : <http://www.ccs-asia.com.sg/>
Email : sales@ccs-asia.com.sg

■ **CCS Inc. Shanghai Office**
Room 308B-309, CIMIC Tower No.1090 Century Avenue,
Pu Dong New Area, Shanghai 200120, P.R. China
TEL : +86-21-5835-8728 / FAX : +86-21-5835-8928
Email : ccschina@ccs-inc.co.jp

■ **CCS Inc. Shenzhen office**
17B, China Economic Trade Building, 7Rd Zizhu, Zhuzilin,
Futian District, Shenzhen 518040 P.R.China
TEL : +86-755-8279-0477 / FAX : +86-755-8279-0478
Email : ccschina@ccs-inc.co.jp